

QUICKCAB CABINETS USER-GUIDE

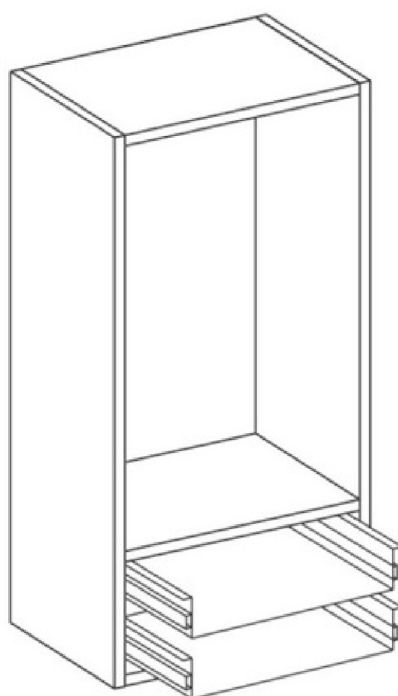

Sustainable quick-build kitchen cabinets available
in a variety of colors.

PLEASE NOTE

The information contained in this literature is for illustrative purposes only to assist in choosing your desired kitchen. While we endeavor to keep the information up to date and correct we do not make any representations or warranties of any kind, express or implied, about the completeness, accuracy, reliability and suitability of the doors and products that appear in this literature.

We aim to showcase as many different items as possible and therefore some products have been installed and photographed purely to show as many of our product features as possible and they should not be taken as an example of how they are intended to be installed in real kitchen installations. It is therefore the responsibility of the installer to check the corresponding manufacturer's installation information and the manufacturer's technical information to ensure this is up to date and to ensure that the products can be fitted in a way they are displayed and the products are suitable for your requirements.

We specifically exclude any liability in this regard unless the products are fitted in accordance with the specifications we supply and the manufacturer's installation recommendations are used in a way recommended by the manufacturer and in accordance with the manufacturer's technical information provided.

The information shown in this literature is accurate as at the date of print/release shown on such information but it may be subject to changes after such date. Please therefore ensure that you are viewing the most current product information available and check with us if you have any doubt about the suitability of the product or accuracy of the information shown.

We are proud that all our products that we sell are covered by a statutory warranty but this does not stop all our products naturally ageing overtime. As a result of this natural ageing process we are therefore unable to provide an identical color finish to the existing products you have purchased from us with any products that we supply you from the same product line. In such an event our liability will be limited to the purchase price paid for the product you are seeking to replace.

Due to the limitations on photographic reproduction, colors may differ slightly from the actual products shown. Please note that board matches listed with the doors are a suggestion only and better board matches may be available on the market. It is up to the individual to decide on its suitability.

Solid 18mm back panel
on base units for strength and rigidity



100mm cross rail
for added stability & practicality



2mm PVC leading edging*
for high impact resistance



Pre-drilled drawer holes
for drawerline, 2 drawer pack & 3 drawer pack

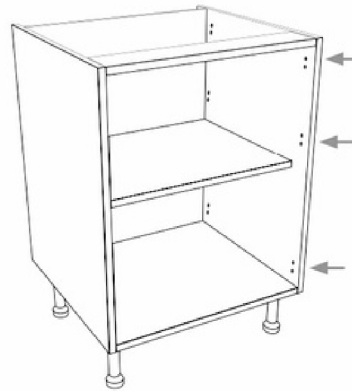

Variable shelf position
with metal studs for easy repositioning

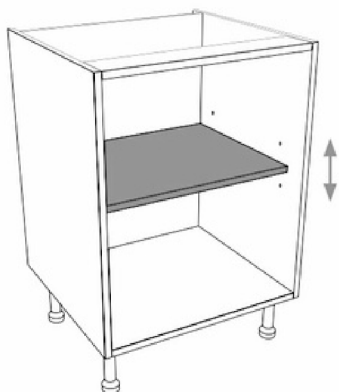

150mm adjustable legs
to compensate for uneven floors



All Quickcab units have a 2mm leading edge on shelves, except for curved units where the radius does not allow this edging to be used. For these items the edging will be 0.8mm ABS tape. All other exposed leading edges will be a 0.4mm melamine edge.

BASE, APPLIANCE & LARDER UNITS

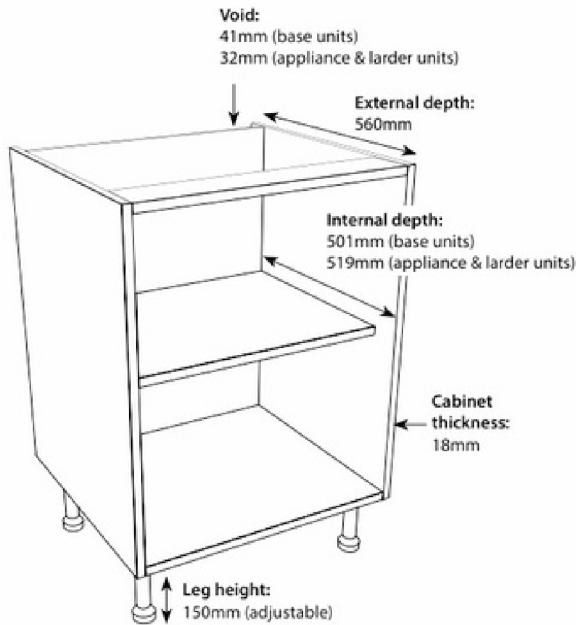

WALL UNITS

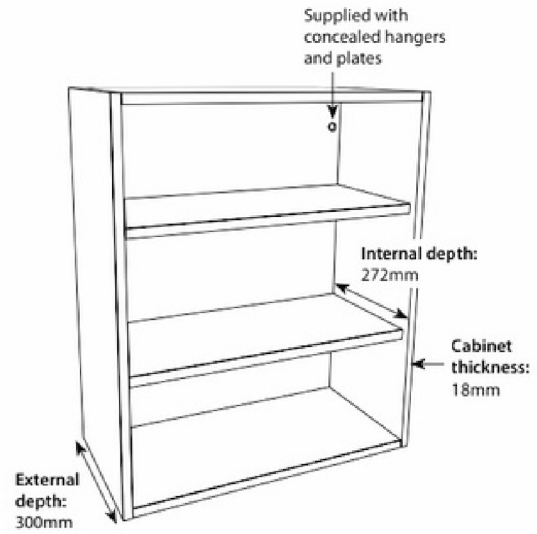

DIMENSIONS

UNIT TYPE	HEIGHT	EXTERNAL DEPTH	BACK THICKNESS	VOID AT BACK
Base Units				
Belfast Base Units	450/490mm	560mm	18mm	41mm
Standard Base Units	720mm	560mm	18mm	41mm
Curved Base	720mm	300mm	18mm	N/A
Wall Units				
Bridging Units	360mm	300mm	8mm	N/A
Standard Wall Units	720mm	300mm	8mm	N/A
Tall Wall Units	900mm	300mm	8mm	N/A
Dresser Units	1210mm	300mm	8mm	N/A

UNIT TYPE	HEIGHT	EXTERNAL DEPTH	BACK THICKNESS	VOID AT BACK
Full Height Units				
Appliance / Larder	1970mm	560mm	8mm	32mm
Curved Full Height	1970mm	300mm	18mm	N/A
Extra Tall Appliance / Larder	2150mm	560mm	8mm	32mm

ADDITIONAL INFORMATION

- All back panels and centre posts are MFC.
- Gables marked for hinges, 100mm hinges.
- All carcasses are supplied without drawers, apart from Smartlarder Complete.
- Includes 5mm colour co-ordinated cover caps

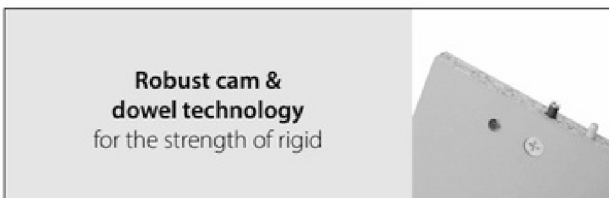

All Quickcab units have a 2mm leading edge on shelves, except for curved units where the radius does not allow this edging to be used. For these items the edging will be 0.8mm ABS tape. All other exposed leading edges will be a 0.4mm melamine edge.

PRICE GROUP 1



WHITE



IVORY

PRICE GROUP 2



LIGHT GREY



STONE GREY



OAK



2:00
mins

build
time



All fittings pre-inserted.

Curved Base Unit 720mm

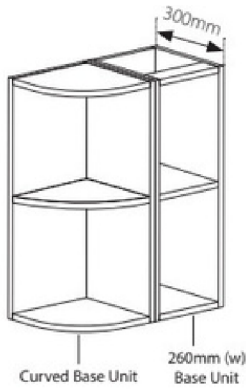

- External curved unit
- Includes 1 shelf
- Legs not supplied with curved base unit
Legs can be purchased separately.

Height: 720mm
Depth: 300mm
Back: 18mm

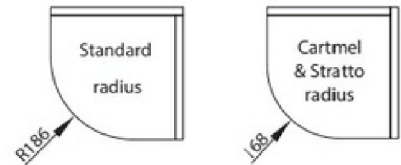

Belfast Base Unit 455/495mm

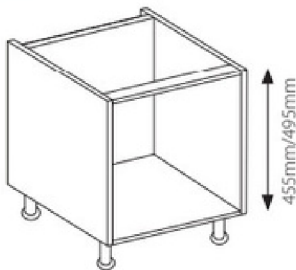

- For use with Belfast Sink
- 455mm height suitable for 450 x 596mm c/c
- 495mm height suitable for 490 x 596mm

Height: 455mm/495mm
Width: 600mm
Depth: 560mm
Back: 18mm

L Shaped Corner Base Unit 720mm

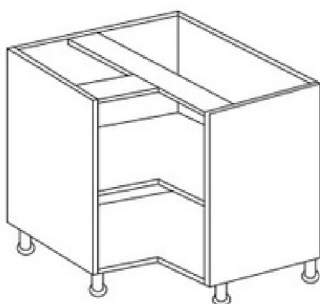

- Includes 1 shelf

Height: 720mm
Size: 900 x 900mm
Back: 18mm

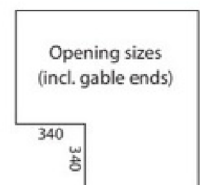



- Includes 1 shelf
- Can be converted into a drawer unit
(comes pre-drilled for drawer line, 2 drawer pack & 3 drawer pack)
- Drawer packs sold separately (nb. 150, 350 & 450mm drawer packs not available)

Height: 720mm
Depth: 560mm
Back: 18mm

Double Base Unit 720mm



- Includes 1 shelf & centre post
- Can be converted into a drawer unit
(comes pre-drilled for drawer line, 2 drawer pack & 3 drawer pack)
- Drawer packs sold separately (nb. 700mm drawer packs not available)
- Converted into a corner base using blanking panel

Height: 720mm
Depth: 560mm
Back: 18mm

Under Oven Housing Unit 720mm

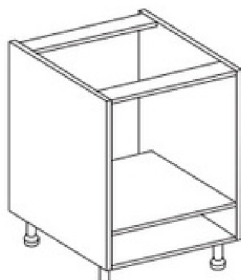

- Includes 1 fixed shelf
- Open back

Height: 720mm
Depth: 560mm

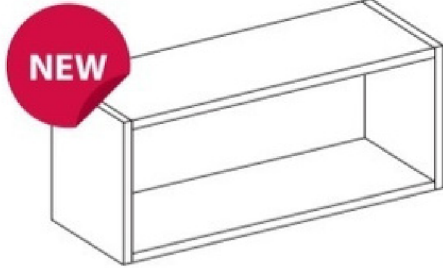
Fridge/freezer Bridging Unit 288mm

- Suitable for 283mm (h) door

Height: 288mm
Depth: 300mm
Back: 8mm

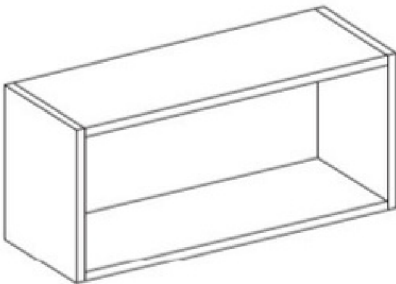
Bridging Unit 360mm

- Suitable for 355mm (h) door

Height: 360mm
Depth: 300mm
Back: 8mm

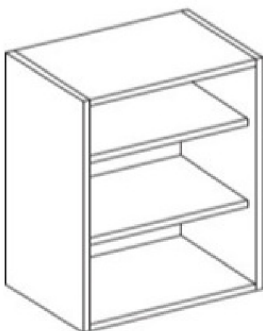
Single Wall Unit 720mm

- Includes 2 shelves

Height: 720mm
Depth: 300mm
Back: 8mm

Double Wall Unit 720mm

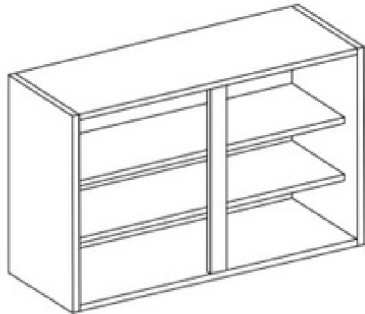

- Includes 2 shelves & centre post

Height: 720mm
Depth: 300mm
Back: 8mm

Curved Wall Unit 720mm

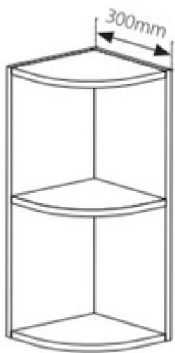

- External curved unit
- Includes 1 shelf

Height: 720mm
Depth: 300mm
Back: 18mm

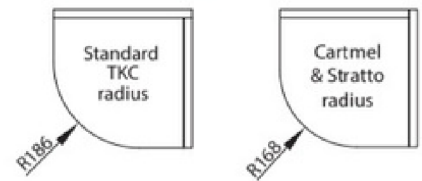

L Shaped Corner Wall Unit 720mm

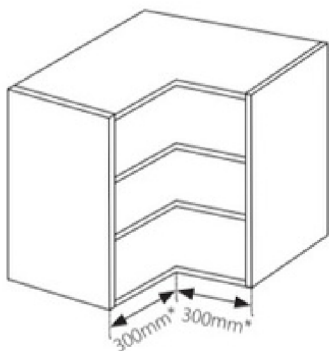

- Includes 2 shelves
- Suitable for 2 x 273-277mm (w) doors

Height: 720mm
Size: 600 x 600mm
Back: 8mm

* Opening sizes including gable ends

Splay Corner Wall Unit 720mm

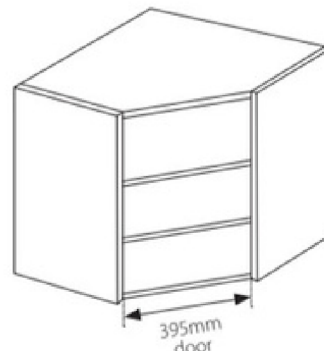

- Includes 2 shelves
- Suitable for a 395mm (w) door

Height: 720mm
Size: 600 x 600mm
Back: 8mm

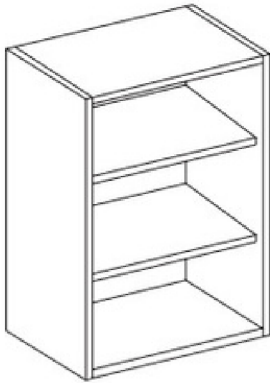
Tall Single Wall Unit 900mm

- Includes 2 shelves

Height: 900mm
Depth: 300mm
Back: 8mm

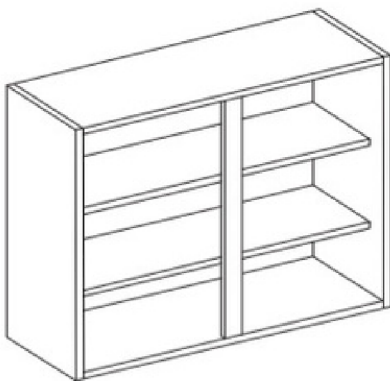
Tall Double Wall Unit 900mm

- Includes 2 shelves & centre post

Height: 900mm
Depth: 300mm
Back: 8mm

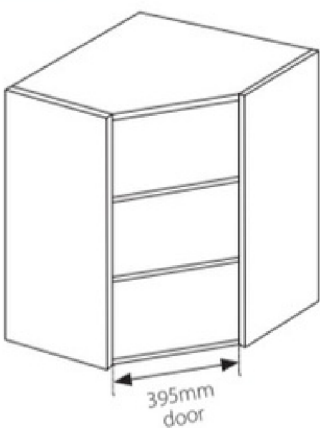
Tall Splay Corner Wall Unit 900mm

- Includes 2 shelves
- Suitable for a 395mm (w) door

Height: 900mm
Size: 600 x 600mm
Back: 8mm

Tall L Shaped Corner Wall Unit 900mm



* Opening sizes including gable ends

- Includes 2 shelves
- Suitable for 2 x 273-277mm (w) doors

Height: 900mm
Size: 600 x 600mm
Back: 8mm

Tall Curved Wall Unit 900mm

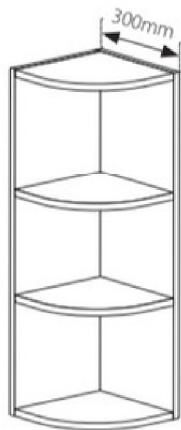

- External curved unit
- Includes 2 shelves

Height: 900mm
Depth: 300mm
Back: 8mm

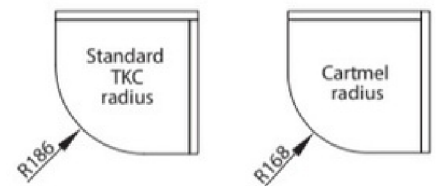

Dresser Unit 1210mm

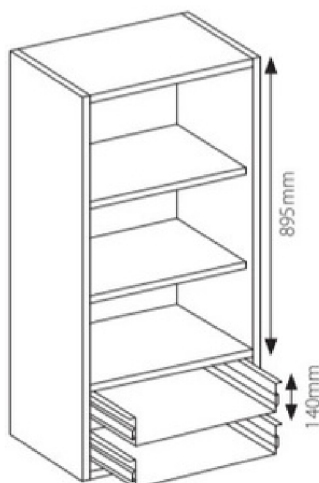

- 2 drawer dresser unit (not suitable for 1 drawer units)
- Includes 2 shelves (Glass shelves can be purchased separately)
- Dresser drawer packs (270mm depth) sold separately
- Suitable for 895mm (h) door & 2 x 140mm (h) drawer fronts

Height: 1210mm
Depth: 300mm
Back: 8mm

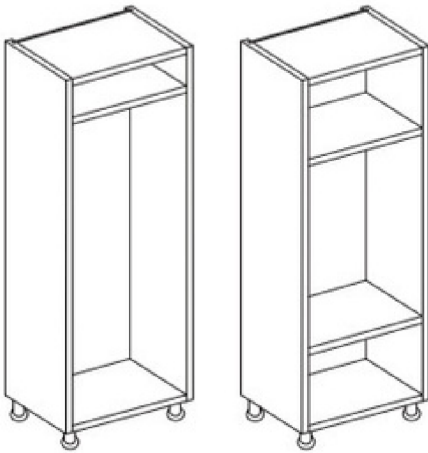
Appliance Unit 1970mm

Fridge/freezer unit

Double oven
housing unit

- Multi purpose unit
- Supplied with gable ends, back and a shelf pack
- Includes top and bottom, 3 fixed shelves and 1 floating shelf

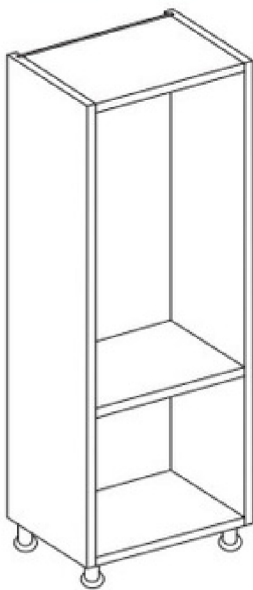
Height: 1970mm**Depth:** 560mm**Back:** 8mm**Larder Unit 1970mm**

- Supplied with gable ends, back and a shelf pack
- Includes top and bottom, 3 fixed shelves and 1 floating shelf to cover multiple configurations

Height: 1970mm**Depth:** 560mm**Back:** 8mm

Curved Full Height Unit 1970mm

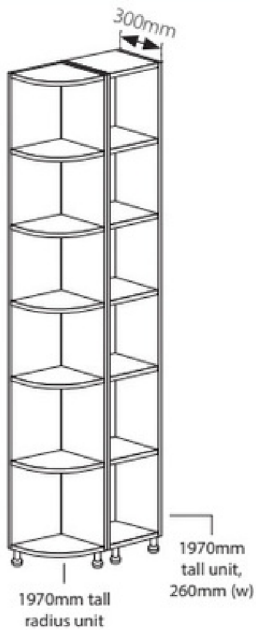

- Includes 5 shelves
- Use with 1245mm curved door and 715mm curved door

Height: 1970mm
Depth: 300mm
Back: 18mm

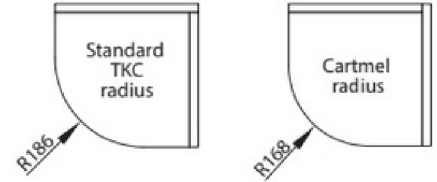

SmartLarder Complete 1970mm

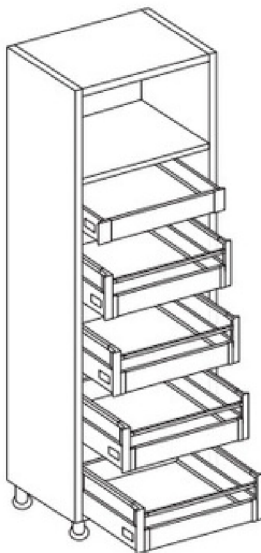

- Includes cabinet, 5 boxed internal drawers & 1 fixed shelf
- Drawer specifications: grey finish, soft closing, 40kg capacity/drawer

Cabinet Height: 1970mm
Cabinet Depth: 560mm
Cabinet Back: 8mm

Fascia panel cutting dimensions:
Internal cabinet width - 97mm
Front rail cutting dimensions:
Internal cabinet width - 63mm

PACK CONTENTS:

- Larder Unit (1970mm) x 1
- Topside boxed shallow drawer & internal bracket (83mm) x 1
- Topside boxed pan drawer, glass conversion kit & internal bracket (224mm) x 4
- Topside internal fascia panel, 1100mm length x 3 (need cutting to size)
- Topside square front rail, 1100mm length x 2 (need cutting to size)
- Silence 165° soft close hinge & Euro 18mm hinge plate x 4

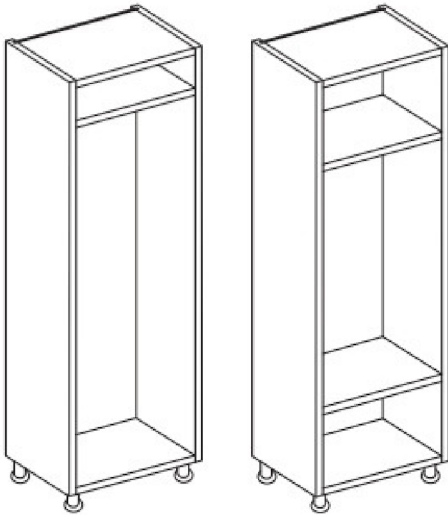
Extra Tall Appliance Unit 2150mm

Fridge/freezer unit

Double oven
housing unit

- Multi purpose unit
- Supplied with gable ends, back and a shelf pack
- Includes top and bottom, 3 fixed shelves and 1 floating shelf to cover multiple configurations

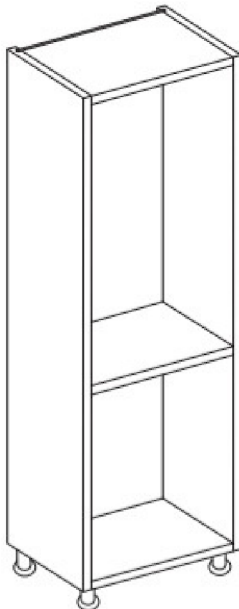
Height: 2150mm**Depth:** 560mm**Back:** 8mm**Extra Tall Larder Unit 2150mm**

- Supplied with gable ends, back and a shelf pack
- Includes top and bottom, 3 fixed shelves and 1 floating shelf to cover multiple configurations

Height: 2150mm**Depth:** 560mm**Back:** 8mm

CORNER BASE UNIT INFORMATION

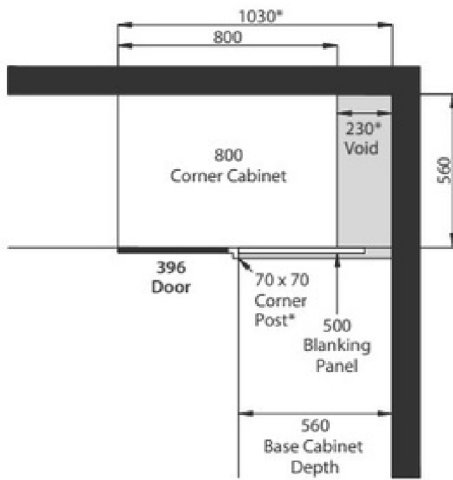

Base Unit: 800mm (w)
Door size: 396mm (w) x 715mm (h)
Blanking panel: 500mm (w), can be cut to size

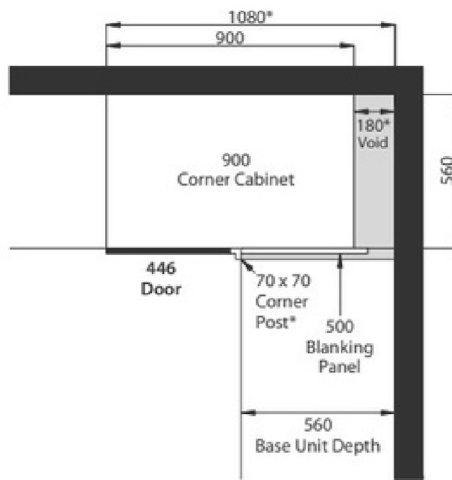

Base Unit: 900mm (w)
Door size: 446mm (w) x 715mm (h)
Blanking panel: 500mm (w), can be cut to size

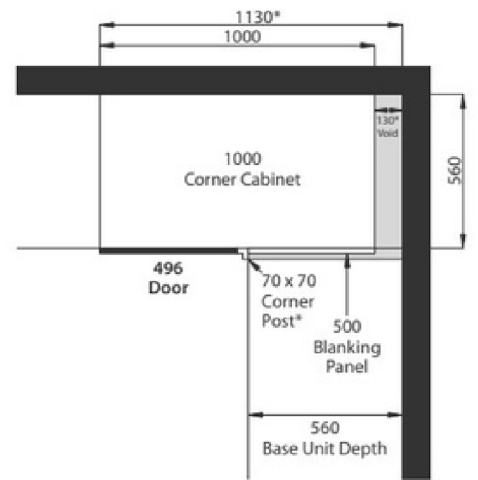

Base Unit: 1000mm (w)
Door size: 496mm (w) x 715mm (h)
Blanking panel: 500mm (w), can be cut to size

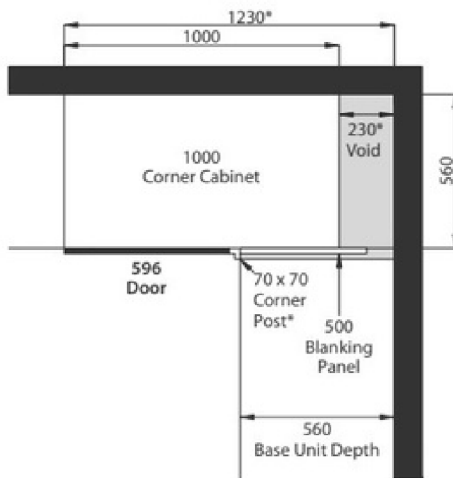

Base Unit: 1000mm (w)
Door size: 596mm (w) x 715mm (h)
Blanking panel: 500mm (w), can be cut to size

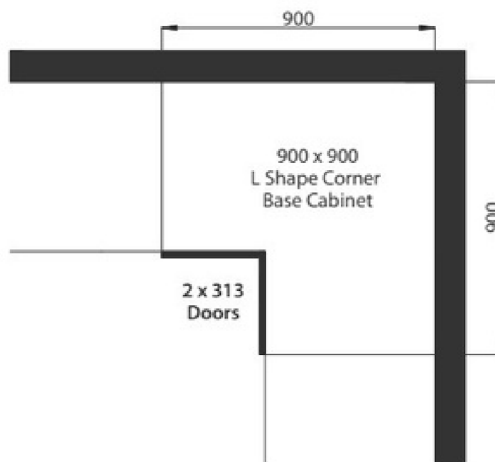

Base Unit: 900 x 900mm L-shape
Door size: 2 x 313mm (w) x 715mm (h)
Hinges: 165° and Pie-cut Corner hinges to be used for the bi-fold corner door

*** PLEASE NOTE:**

Dimensions are based on 70 x 70mm Vivo slab corner post. Corner post sizes vary between ranges which affects the size of the required distance from wall to end of corner cabinet. Please make sure the distance is adjusted to reflect the size of the corner post for the specific door range.

eg. Lucente J-pull corner posts are 60 x 60mm which means distance from wall to end of corner cabinet is 10mm shorter.

Void is covered by the worktop after installation.

Guide to LH / RH corner wirework units

Wirework is handed by the side the door is on. The door is hinged on the side that the blanking panel is on (applies to Combi pull out shelves).

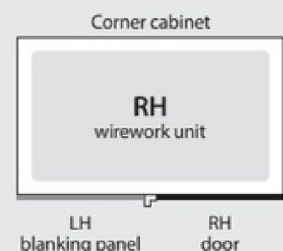
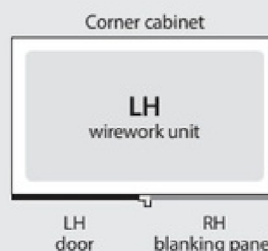

CORNER WALL UNIT INFORMATION

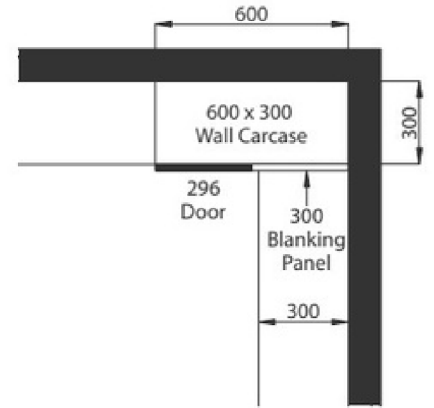
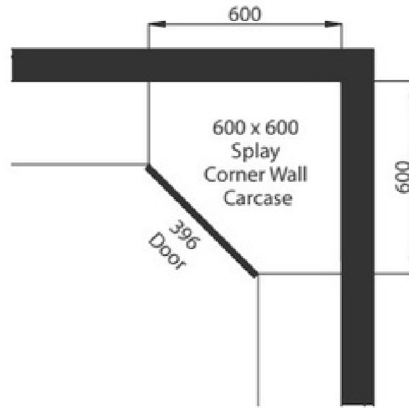
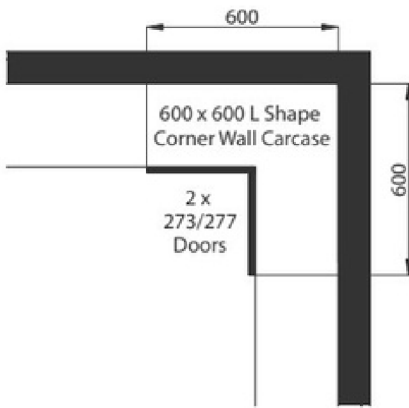

Wall Unit: 600 x 600mm L-shape
Door size: 2 x 273/277mm (w) x 715mm (h)
Hinges: 165° and Pie-cut Corner hinges to be used for the bi-fold corner door.

Wall Unit: 600 x 600mm D-shape
Door size: 396mm (w) x 715/895mm (h)

Product Code: 600mm
Wall Unit: 600 x 300mm conventional corner
Door size: 296mm (w) x 715mm (h)

CURVED UNIT DOOR CONFIGURATIONS

Medium (1970mm) and tall (2150mm) installation heights

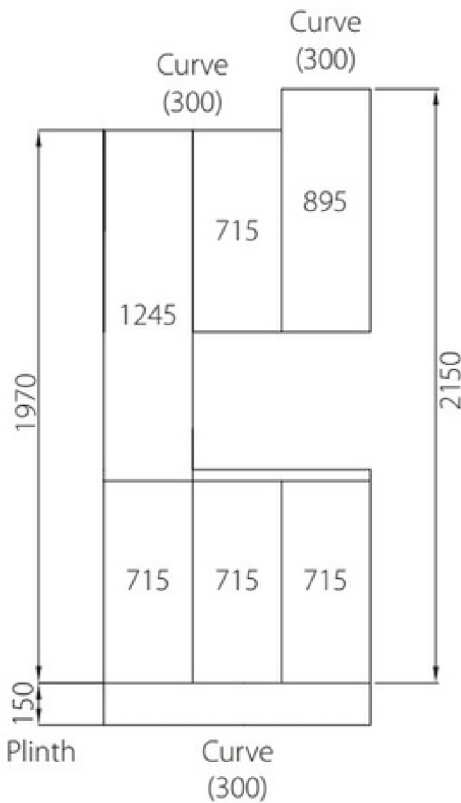

BASE & TALL

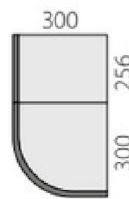

WALL

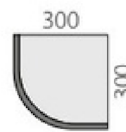

RADIUS

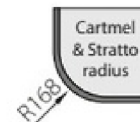
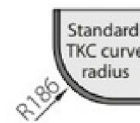



STAY CONNECTED

sales@directkitchendoorsuk.com
www.directkitchendoorsuk.com
@directkitchendoors

